

GENERAL DESCRIPTION

Resilient plastic housing
 Standard metric spigot
 Integral terminal box
 G2.5 precision balanced impeller
 High efficiency impeller

Thermally protected motor
 IP44 ingress protection
 Class F insulated motor
 Electronic control compatible
 Motorised impeller fitted with sealed for life ball bearings.

Model	Voltage (V)	Frequency (Hz)	Power (Wa)	Max Current (A)	Speed (rpm)	Max airflow (M³/h)	Max Air temp. (°C)	Weight (Kg)
RS 160	230	50	70	0.31	2520	440	60	3.1
RS160L	230	50	125	0.54	2515	660	45	3.5

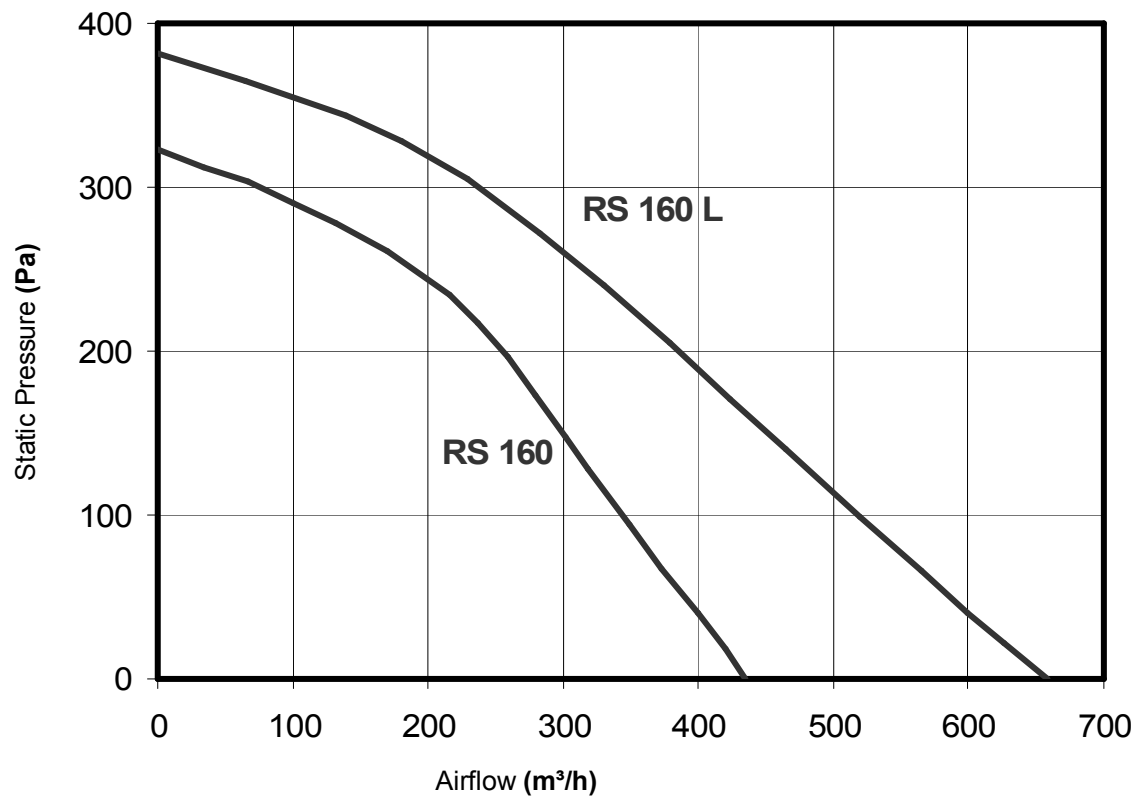
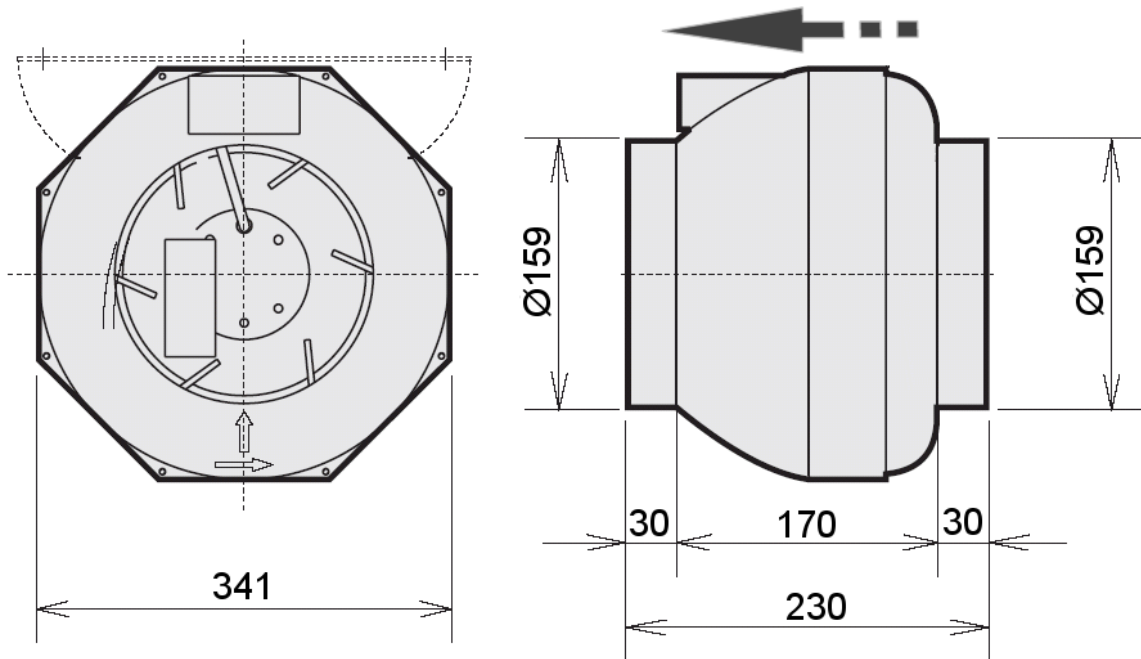

In-Line Duct Fans—Plastic Cased Installation and Maintenance

It is intended that this range of products should be installed by a fully qualified and competent person. The fan is fitted with a high quality external rotor motor, manufactured by Ecofit in France. The fan assembly is dynamically balanced before assembly into the plastic case and this ensures smooth running for the life of the product. The ball bearings are sealed for life and are non-serviceable item. This particular range of ILDF is not suitable for the removal of inflammable vapours and must not be used in such situations.

Packaging and Delivery

The fan must be inspected for transit damage before any attempt to install it is made. The fan will have left our premises in perfect condition, protected in a cardboard box. If there are any doubts as to the condition of the fan it MUST be noted on the carriers delivery paperwork.

Handling

All the units must be handled with care at all stages, the ILDF must NOT be carried by the connecting cable, or the blades of the fan motor.

Installation-mechanical

The fan is designed to operate in any orientation. The RS range of fans is probably the quietest of their type available on the market but in positioning the fan you should take into consideration any people working or living in the immediate vicinity. Additional noise data and advice is available on the [Fanbuyer](#) web site.

The fans should be fitted internally onto a rigid, flat surface, typically a building wall or purlin. The mounting bracket should be screwed in position before the fan is fitted to the bracket. Rotate the fan so that the terminal box is easily accessible. The fan must not be directly exposed to water spray or steam or heat (in excess of 45°C). The weight of the fan is stated on the web site and the installer must ensure that the structure is strong enough to accept the extra loading.

ATTENTION: The fan consists of fast rotating parts, and is a dangerous machine! The ducting should be connected before the fan is switched on. It is the sole responsibility of the installer to ensure that the fan cannot be operated in an unsafe or dangerous manner.

Installation-electrical

Note: All our fans are fitted with a thermal protector, embedded in the windings of the motor. Should the motor overheat the fan the thermal protector will cut the supply to the motor. When the motor has cooled down the motor will restart. It is imperative that the power is disconnected before carrying out any investigation into the cause of a motor stopping.

The rating label gives details of the motor power and the correct size and rating cable must be selected. An isolator should be fitted as part of the motor protection circuitry, a fuse is NOT an adequate method of protection.

It is important that the electrical demand does not exceed the data on the motor rating label; particularly the current drawn (A). The fan should be allowed to run for a minimum of 1 hour to allow the current (A) to settle. After 1 hour the fan should be switched off and the installation checked to ensure that nothing has worked loose; electrical connections and also mechanical fixings.

It is vital that the motor is NOT operated in reverse because the blades have been optimised for the maximum performance in a single direction of rotation. Verify that the airflow is in the same direction as the indicative arrows on the plastic casing.(on the opposite side to the terminal box)

Warranty

The plastic in-line fans are guaranteed for 12 months from the date of delivery and covers faulty materials and workmanship. The earlier warnings about correct installation are important and any failures that might be attributed to poor installation practices will void the warranty.